

LOS APLECHES
DINS L'ARQUITECTURA

Loís GAUBÈRT
Miquèl GONIN

Aquel manuscrit es mes en forma electronicament per Ieo edicions
Es consultable a gratis sul nòstre siti.

Tota utilisacion non consultativa deurà far l'objècte d'una demanda alprèp de ieo edicions

Aquela òbra demòra l'entiera propietat
de sos autors Miquèl Gonin e Lois Gaubert

Los apleches del maçon

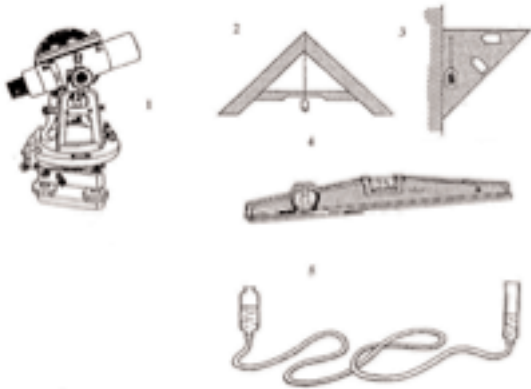

Nivèl

- 1 : Teodolit
- 2 : De maçon
- 3 : De rebocaire
- 4 : Amb bodenfla d'aire
- 5 : A aiga



Plomb o plombèl o rainal



Sedàs o crivèl o tamís



Bocharda

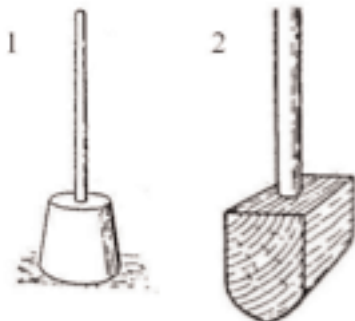

- 1 : Pilon o trissador
- 2 : Pisador o batedor de tàpia



- 1 : Sargent
- 2 : Cavilheta



Gata o gamacha



Tibla

- 1 : per alisar
- 2 : per maçonar la brica
- 3 : per bastir
- 4 : per perbocar
- 5 : per preparar lo mortier, dicha *lenga de buòu*
- 6 : dicha *lenga de cat*, per far de trabalh fin
- 7 : lisador per far los junts

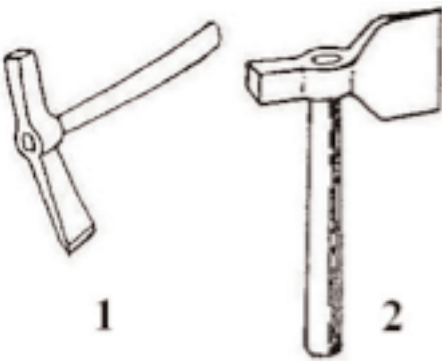

1 : Rostit
2 : Testut

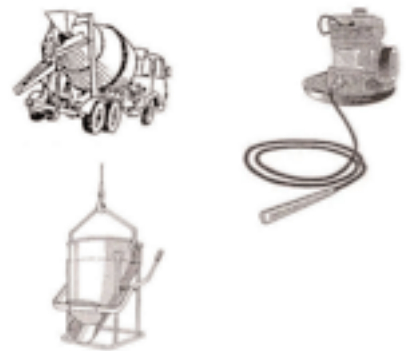

Camion malaxaire
Bena a betum
Agluha vibranta o vibrador

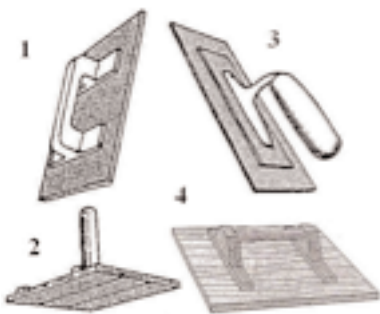

Talòssa

- 1 : normala
- 2 : pel plafon
- 3 : alisa
- 4 : en fust, pel crespiment grossièr



Cisèl



Gorbia

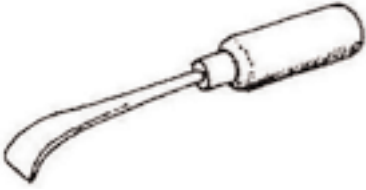

Gratador



1 : Pic
2 : Descintradador o descindrador



Redable o pastamortier



Pinças
1 : per cindrar las armaduras de fèrre o arpa
2 : per desmargar los cofratges

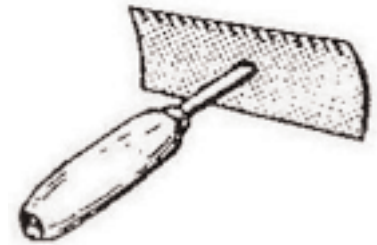

Tibla brecada



Doladoira

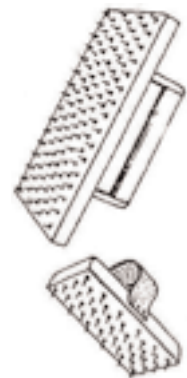

Rebocaire

Los del menusièr

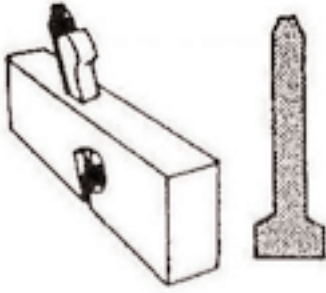

Guilharmes



Plana o cotèl de doas mans

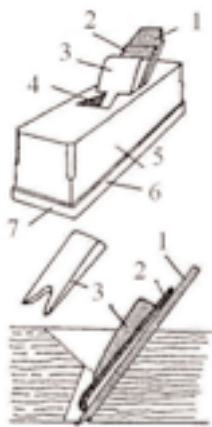

- 1 : Fèrre
- 2 : Subfèrre
- 3 : Cunh
- 4 : Lumiera
- 5 : Fust
- 6 : Sòla
- 7 : Nas

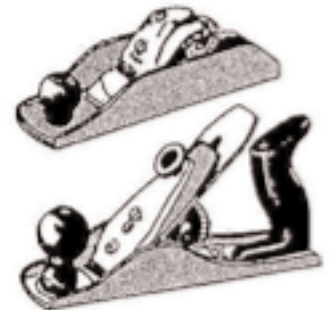

Rabòts modèrnes

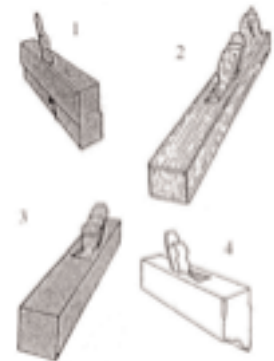

- 1 : Bovet
- 2 : Garlòpa
- 3 : Riflard
- 4 : Rabòt quart-de-rond



Maceta
en cauchó
en fust



Virabiqui

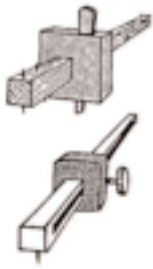

Trosquins

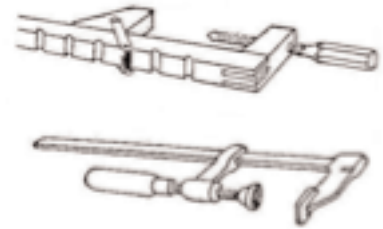

Sargents



Escalpre



Riflards

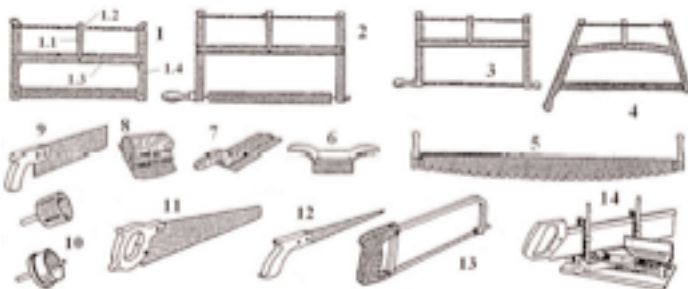

Rèssas

- 1 :
- 1.1 : clau
 - 1.2 : garròt o bilha
 - 1.3 : saumièr
 - 1.4 : braç
- 2 : per arrasar o per ressar en long
- 3 : per chantornar
- 4 : savoiarda
- 5 : toradoira o tora o torador
- 6 : de parquetaire
- 7 : per enrasar
- 8 : pel placatge
- 9 : pel contraplacat
- 10 : rèssa-trepan
- 11 : resset
- 12 : passapertot o toradoira o tornissa
- 13 : pel metal
- 14 : per far d'onglets

Górbia o cisèl pel fust

- a : seda
- b : embasa
- c : colet
- d : bisèl
- e : trencant o talhant
- f : chanfren o plumet
- g : lama

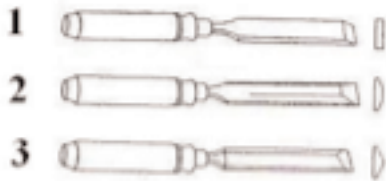
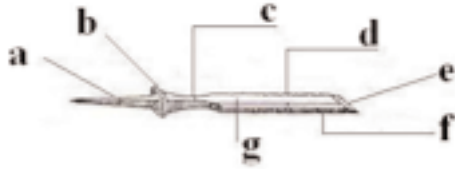

- 1 : cisèl drech
- 2 : amb chanfren
- 3 : bèc d'aine o bèc d'ase



Gojas



Clavèls

- 1 : per ondrar dich *a ala de mosca*
- 2 : per la palmèla
- 3 : sens cap, de vitrièr
- 4 : tacha
- 5 : d'ondradura
- 6 : de tapissier; o guingasson; o tacheta
- 7 : del cap mièg-redond (teulada e tapissariá)
- 8 : del cap redond
- 9 : piton
- 10 : dich *vitz fals* per permetre lo desmontatge
- 11 : per fixar las tòlas
- 12 : tòrs per la maçonariá e la carpenta
- 13 : en laton, per ondrar
- 14 : pel fust, amb cap d'òme
- 15 : pel fust, amb cap planièr
- 16 : per la teula, lo malon
- 17 : pel betum
- 18 : de maçon

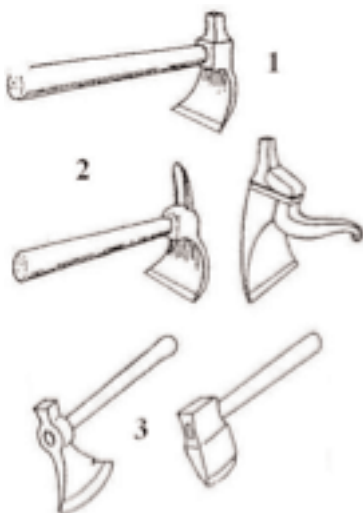

Aissas e pigassons

- 1 : aissa amb cap
- 2 : aissa amb goja
- 3 : pigassons

Los del fustièr



Vironas



Besaguda



Clau a pipa per la carpenta metallica



Doladoira



Gojas

Los del teulaire



Cisalha per copar la lausa

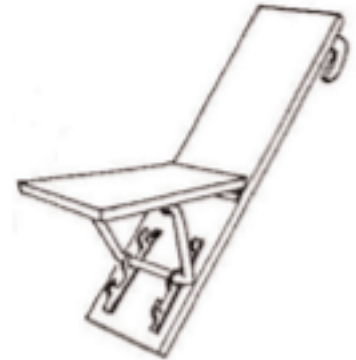

Aucèl



Ponchon pel zinc

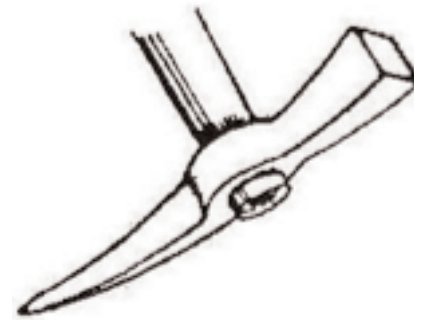

Martelet



Aissòla



Pinças per orlar lo zinc o plegadoira

Los modèrnes

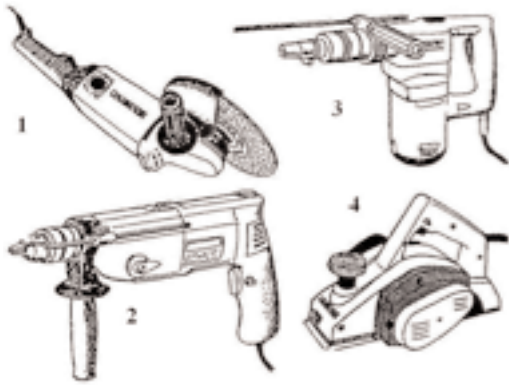

- 1 : Amoladora o amolaira
- 2 : Perforadora
- 3 : Perforador-burinador
- 4 : Rabòt electric

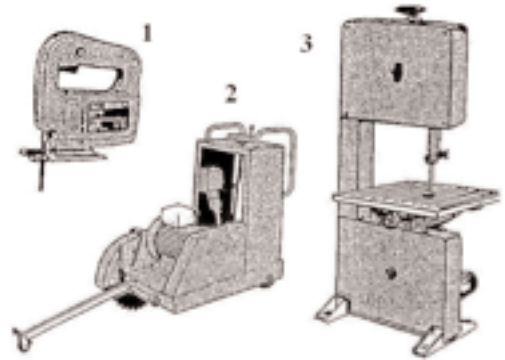

- 1 : Rèssa saltaira
- 2 : Rèssa per ressar los sòls
- 3 : Rèssa amb riban

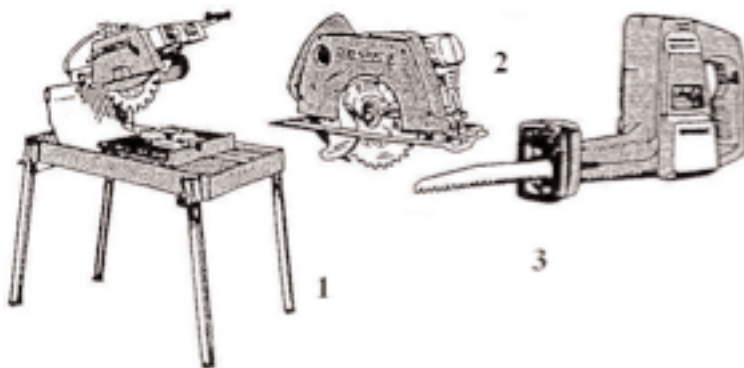

- 1 : Rèssa de maçon
- 2 : Rèssa circulara portativa
- 3 : Ressel portatiu

Los del peirièr



Bocharda



Maça, maçòt, malh e malhet

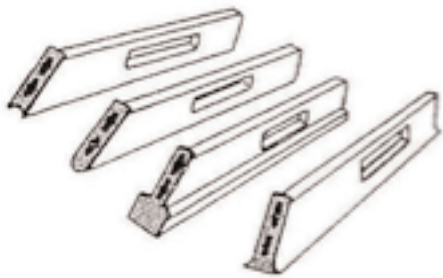

Guilharmes



Ponchon



1 : Escalpre
2 : Riflard o gradina

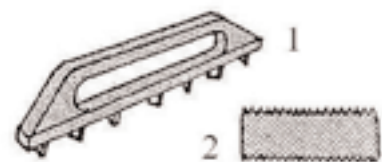

1 : Rèssa
2 : Rastèl



Passa



Gorbia

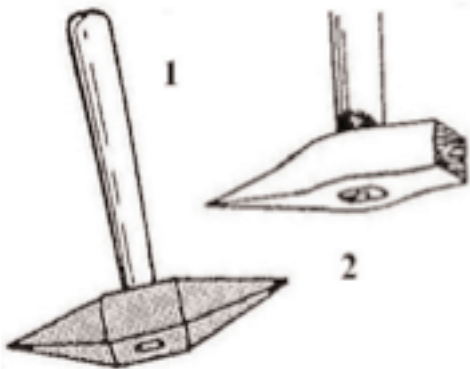

1 : Escoda
2 : Martelèta

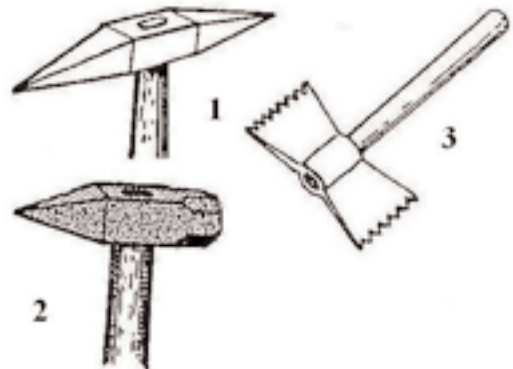

1 : Encapaire
2 : Pic
3 : Estampin

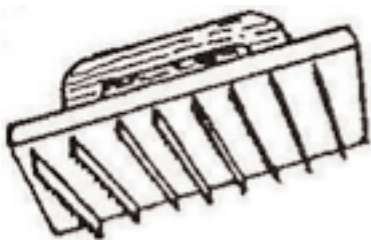

Rabotet o camin de fèrre



Sageta



Barramina

Los del malonaire



Gamacha o barquet



Tibla carrada
2 : redonda

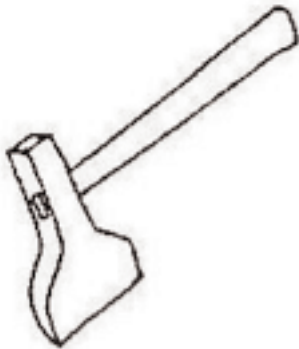

Pigasson

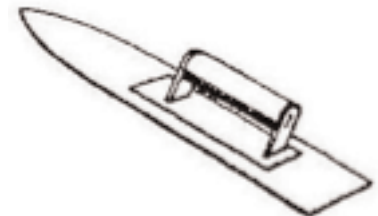

Talòssa dicha *flamenca*

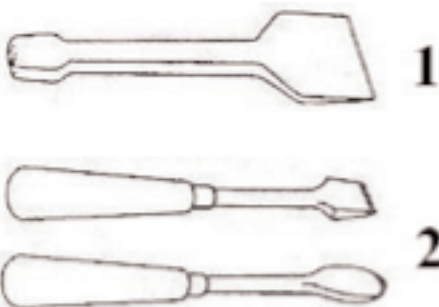

Ciséls

1 : per copar las bricas

2 : de malbrièr amb cap carrat o redond



Pinças per copar lo mosaïc

Los del cantonièr



Virona per forar de tèrras doças

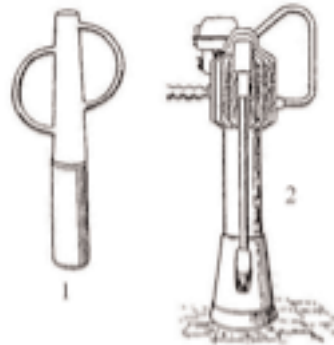

1 : Dama
2 : Dama mecanica

Los que servisson a portar

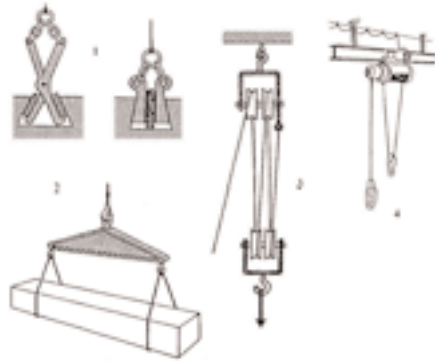

- 1 : Loba
- 2 : Esparra
- 3 : Mofle
- 4 : Palanc electric

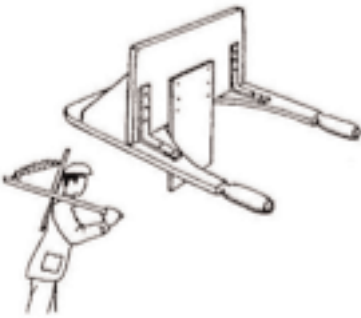

Aucèl de maçon

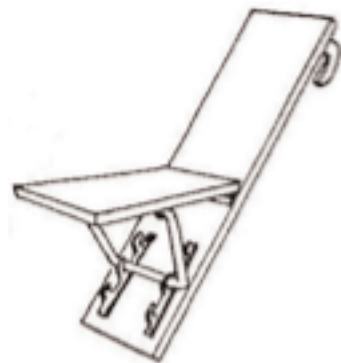

Aucèl de teulaire

Los de l'electrician

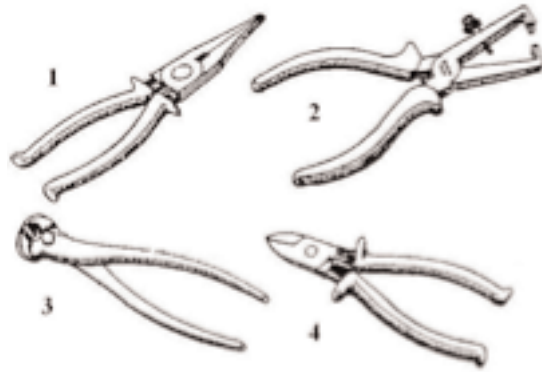

Pinças

1 : telefòn

2 : per pelar los fials electricos

3 : talhenta

4 : talhenta

Los del plombièr



Calibrador o mandrin

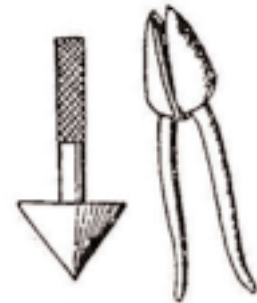

Fresa



Raspador

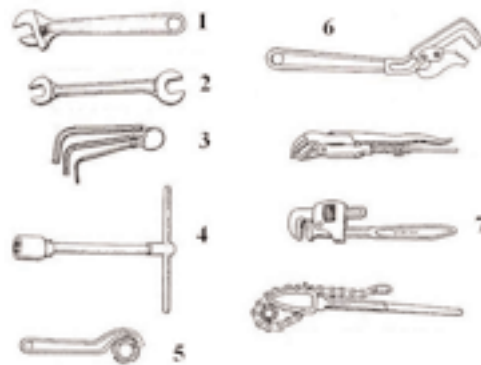

Claus

- 1 : dicha anglesa
- 2 : planièra
- 3 : dicha Alen
- 4 : amb dòlhas amoviblas
- 5 : amb det
- 6 : universala
- 7 : per téner los tubs



Pinças

- 1 : cindraira pels tubs de coire
- 2 : pel gas
- 3 : multipresa
- 4 : fresa
- 5 : pel sanitari
- 6 : copa-plomb
- 7 : estòc

Los del pintor



Bròssas e pincèls

- 1 : redonda
- 2 : planièra
- 3 : coidada
- 4 : per pegar o encolar
- 5 : per la pintura a l'aiga
- 6 : per preparar los supòrts
- 7 : per far d'obratges menuts
- 8 : per desempolsar los enduches e molhar los murs
- 9 : per descapar los metalls
- 10 : per pegar e alisar la tapissariá
- 11 : per far de linhas crosadas
- 12 : per pintrar de repapilhotís



- 1 : Paleta
- 2 : Rastèl per empegar
- 3 : Rotlèu

Los del platrièr



Gamacha o nauc



Tibla

- 1 : triangulara o esbarbador
- 2 : de cap carrat
- 3 : tiblon
- 4 : paleta



Pigasson



Talòssa amb una lama en inòx o alisa o plastrador



Tibla dentada

Los del vitrièr



Gratador o tira-plomb

Los del sarralhièr



Ponchon



1



2



3



4



5

Cisalhas

1 : electrica per copar la tòla

2 : per copar los cables

3 : per chantornar

4 : universal

5 : per la tòla

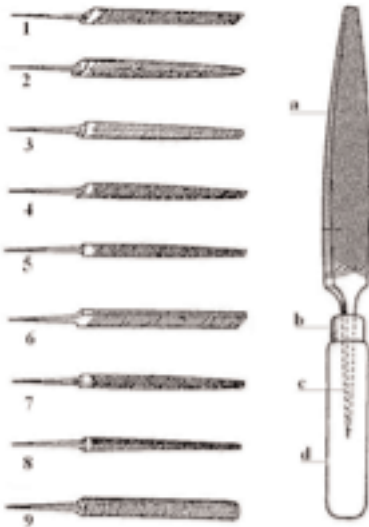

Lima

a : vèrga

b : viròla

c : seda

d : margue

1 : cotèl

2 : fuèlha de sàlvia

3 : mièja-redonda

4 : per agusar las rèssas

5 : tèrçpont

6 : planièra

7 : carrada

8 : en coa-de-rat

9 : redonda

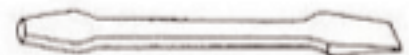

Trancha : cisèl per copar la tòla



1 : Viron dich *lenga d'aspic*
2 : Vironet dich *lenga de carpa*



Pinças

- 1 : universal
- 2 : amb de bès planiers
- 3 : amb de bès redonds

